

JUST BLACK LINE SURFACE

A33300-

base number LED
Dimming

- To build a product code in our configurator select the specify button on the base model # product page
- To build a manual product code on this datasheet choose from the options listed below in blue font and add the suffix to the base model #

GENERAL

Series: Just Black Line
Brand: Prolicht
Division: Architectural
Mounting Type: Surface
Mounting Location: Wall
Subcategory: Wall Effect

PHYSICAL

Shape: Rectangle
Length (mm): 900
Length (in): 35 ⁷/₁₆
Width (mm): 30
Width (in): 1 ³/₁₆
Height (mm): 40
Height (in): 1 ⁹/₁₆
Light Distribution: Indirect
Fixture Finish: BLK
Fixture Material: Aluminum

ELECTRICAL

Lamp Type: LED (Zhaga Standard)
Input Wattage (W): 11
Total Output Wattage (W): 10
[Dimming: Non-Dimmable](#)
Driver Included: Yes
Driver Location: Integrated
Driver Type: Constant Current - Universal
Driver Class: Class 2
Input Voltage (V): 120 - 277
Constant Current (mA): 400
Upon Request: Tri-Mode Dimming

LED

Color Temperature (°K): 3000
Max. Delivered Lumen (lm): 535
Nominal Lumen (lm): 535
CRI: >80 CRI
Lamp Life (hrs): 50000

OPTICAL

Beam Angle: 178
Adjustability: Fixed

RATINGS AND CERTIFICATIONS

Certified By: CSA Certified to UL and CSA Standards
IP rating: IP20

| |
|-----------|
| PROJECT |
| TYPE |
| SPECIFIER |
| QUANTITY |
| DATE |



JUST BLACK LINE SURFACE

A33301-

base number LED
Dimming

- To build a product code in our configurator select the specify button on the base model # product page
- To build a manual product code on this datasheet choose from the options listed below in blue font and add the suffix to the base model #

GENERAL

Series: Just Black Line
 Brand: Prolicht
 Division: Architectural
 Mounting Type: Surface
 Mounting Location: Wall
 Subcategory: Wall Effect

PHYSICAL

Shape: Rectangle
 Length (mm): 1500
 Length (in): 59 1/16
 Width (mm): 30
 Width (in): 1 3/16
 Height (mm): 40
 Height (in): 1 9/16
 Light Distribution: Indirect
 Fixture Finish: BLK
 Fixture Material: Aluminum

ELECTRICAL

Lamp Type: LED (Zhaga Standard)
 Input Wattage (W): 15
 Total Output Wattage (W): 13.6
 Dimming: [Non-Dimmable](#)
 Driver Included: Yes
 Driver Location: Integrated
 Driver Type: Constant Current - Universal
 Driver Class: Class 2
 Input Voltage (V): 120 - 277
 Constant Current (mA): 580
 Upon Request: Tri-Mode Dimming

LED

Color Temperature (°K): 3000
 Max. Delivered Lumen (lm): 776
 CRI: >80 CRI
 Lamp Life (hrs): 50000

OPTICAL

Beam Angle: 178
 Adjustability: Fixed

RATINGS AND CERTIFICATIONS

Certified By: CSA Certified to UL and CSA Standards
 IP rating: IP20

| |
|-----------|
| PROJECT |
| TYPE |
| SPECIFIER |
| QUANTITY |
| DATE |



| | |
|-----------|-------|
| PROJECT | _____ |
| TYPE | _____ |
| SPECIFIER | _____ |
| QUANTITY | _____ |
| DATE | _____ |

JUST BLACK LINE SURFACE

A33302-

base number LED
Dimming

- To build a product code in our configurator select the specify button on the base model # product page
- To build a manual product code on this datasheet choose from the options listed below in blue font and add the suffix to the base model #

GENERAL

Series: Just Black Line
 Brand: Prolicht
 Division: Architectural
 Mounting Type: Surface
 Mounting Location: Wall
 Subcategory: Wall Effect

PHYSICAL

Shape: Rectangle
 Length (mm): 1200
 Length (in): 47 3/4
 Width (mm): 30
 Width (in): 1 3/16
 Height (mm): 220
 Height (in): 8 2/3
 Light Distribution: Indirect
 Fixture Finish: BLK
 Fixture Material: Aluminum

ELECTRICAL

Lamp Type: LED (Zhaga Standard)
 Input Wattage (W): 14.5
 Total Output Wattage (W): 12.7
 Dimming: [Non-Dimmable](#)
 Driver Included: Yes
 Driver Location: Integrated
 Driver Type: Constant Current - Universal
 Driver Class: Class 2
 Input Voltage (V): 120 - 277
 Constant Current (mA): 550
 Upon Request: Tri-Mode Dimming

LED

Color Temperature (°K): 3000
 Max. Delivered Lumen (lm): 736
 CRI: >80 CRI
 Lamp Life (hrs): 50000

OPTICAL

Beam Angle: 178
 Adjustability: Fixed

RATINGS AND CERTIFICATIONS

Certified By: CSA Certified to UL and CSA Standards
 IP rating: IP20

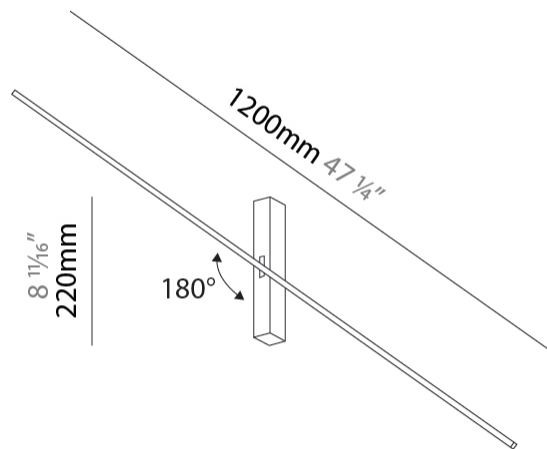

PROJECT

TYPE

SPECIFIER

QUANTITY

DATE

Fixture Finish

Black - BLK (BLK)



Digital: Not all screens are calibrated the same, and therefore, colors will appear differently between screens.

Physical: When texture is involved, there will be variations in color, character and tone within a product series and between product families.

Gun Metal: No Gun Metal finish is alike. It combines a mixture of transparent and black color particles which ensures a highly individual effect and no luminaire being identical.











Champagne Cream, Copper Mine, Ancient Bronze + Jazz Gold: These finishes have slight fading from specific powder coating production. Each luminaire will slightly vary.



LEGEND

| | | | | | |
|--|---|---|--|---|--|
|  | floor-mounted |  | pivotal |  | special LED (upon request) RGB, RGBW, tunable, gold+, meat+, art+, fashion+ |
|  | wall and ceiling: recessed and surface mounted |  | rotating |  | warm dim / natural dimming LED |
|  | ceiling-mounted and wall-mounted |  | illuminate tilted |  | rechargeable battery powered |
|  | wall-mounted |  | color of suspension cable |  | fixture with natural vivid LED (upon request) |
|  | omni-directional light distribution |  | length of suspension cable |  | color rendering index |
|  | direct light distribution |  | reflector degree selection |  | color temperature |
|  | direct/indirect light distribution |  | super spot |  | lumen (luminous flux) |
|  | indirect light distribution |  | lens |  | efficacy (lumens per watt) |
|  | asymmetric light distribution |  | lens pack |  | Unified Glare Rating (UGR) range from 5-40 |
|  | aura light distribution |  | shine ring |  | marine grade (AISI 316 stainless steel) |
|  | round wall or ceiling cut-out |  | integrated shine ring with diffuser |  | walk on |
|  | square wall or ceiling cut-out |  | free individual colors 01-29 |  | drive on |
|  | the supplied jig specifies the cutout dimensions |  | individual colors: 00 (free of charge), 01-25 (extra charge) |  | Dark Sky Compliance |
|  | minimum distance (meters) lamp - object |  | luminaire part to be colored (F1) |  | Americans with Disabilities Act (less than 4" off the wall located between 27"-84" from floor) |
|  | recessed depth |  | luminaire part to be colored (F2) |  | lamp protected against explosion |
|  | ceiling thickness in mm |  | luminaire part to be colored (F3) |  | blown glass using traditional methods by master glass blower |
|  | ceiling thickness selection |  | luminaire part to be colored (F4) |  | acoustic material |
|  | dimnable DP (phase), DV (0-10V), DD (dali), DS (step-dim) |  | luminaire part to be colored (F5) |  | protection class I, protection insulation |
|  | included or excluded LED driver/transformer/control gear |  | color of 3-circuit adaptor |  | protection class II, protection insulation |
|  | separately switchable |  | indirect diffuser |  | ETL Certified to UL and CSA Standards |
|  | sensor |  | direct diffuser |  | UL Certified to UL and CSA Standards |
|  | remote control |  | ball-proof (upon request) |  | CSA Certified to UL and CSA Standards |
|  | available upon request |  | accessory |  | Certified for North American Standards |

IP RATING

| | |
|---|--|
|  | protected against ingress of solid bodies greater than 12.5mm (finger) |
|  | protected against ingress of solid bodies greater than 2.5mm protected against sprays of water up to 60 degrees from the vertical (rain) |
|  | protected against ingress of solid bodies greater than 1mm (wire) no protection against the ingress of moisture |
|  | protected against ingress of solid bodies greater than 1mm (wire) protected against sprays of water up to 60 degrees from the vertical (rain) |
|  | protected against ingress of solid bodies greater than 1mm (wire) protected against water splashed from all directions |
|  | protected against limited ingress of dust (wet rooms/covered outdoor areas) protected against water splashed from all directions |
|  | protected against ingress of dust protected against jets of water |
|  | protected against ingress of dust protected against powerful jets of water or heavy seas |
|  | protected against ingress of dust protected against immersion of water between 15cm - 1m for 30 minutes |
|  | protected against ingress of dust protected against immersion of water under pressure for long periods |

IK RATING

| | |
|---|---|
|  | protected against 0.14 joules impact (equivalent to 0.25kg mass dropped from 56mm above the surface) |
|  | protected against 0.2 joules impact (equivalent to 0.25kg mass dropped from 80mm above the surface) |
|  | protected against 0.35 joules impact (equivalent to 0.25kg mass dropped from 140mm above the surface) |
|  | protected against 0.5 joules impact (equivalent to 0.25kg mass dropped from 200mm above the surface) |
|  | protected against 0.7 joules impact (equivalent to 0.25kg mass dropped from 280mm above the surface) |
|  | protected against 1 joules impact (equivalent to 0.25kg mass dropped from 400mm above the surface) |
|  | protected against 2 joules impact (equivalent to 0.5kg mass dropped from 400mm above the surface) |
|  | protected against 5 joules impact (equivalent to 1.7kg mass dropped from 300mm above the surface) |
|  | protected against 10 joules impact (equivalent to 5.0kg mass dropped from 200mm above the surface) |
|  | protected against 20 joules impact (equivalent to 5.0kg mass dropped from 400mm above the surface) |